

BEST TRAINING

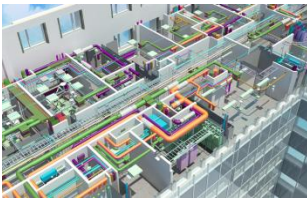

Fundamentals of M&E Consultancy



Fundamentals of Electrical Services

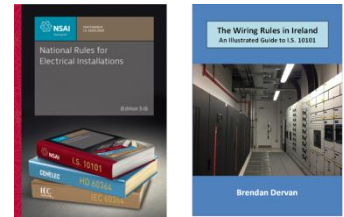

New Wiring Rules (IS10101)



Data Centres M&E services



MV Distribution Design



LV Power - Wiring Systems

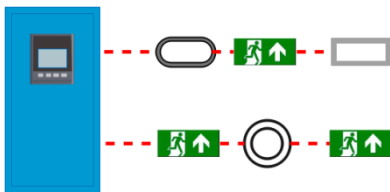

Emergency Lighting Systems



Fire Alarm and Fire suppression Systems



LV Power - Switchgear

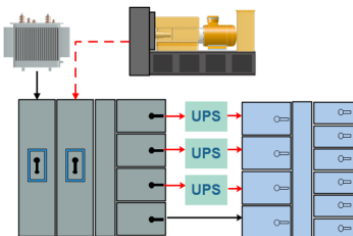

Critical Power Installations



UPS Systems



Standby Generator Systems

CPD Courses - 2023-24

Edition	Date	Details
1	Oct 2022	First Issue
2	Nov 2022	Minor corrections
3	Aug 2023	Pricing Removed
4	Sep 2023	Amendments to Data Centre- Introduction to M&E Services

Contact Details

Brendan Dervan,
Best Training, 187 Orwell Park Heights,
Templeogue, Dublin 6W, D6WH049

Website: www.besttraining.ie

Email: brendan@besttraining.ie

Mobile: 353 87 2628188

INTRODUCTION 3

GENERAL INFORMATION ON CPD COURSES 4

FUNDAMENTALS OF M&E CONSULTANCY 6

FUNDAMENTALS OF ELECTRICAL SERVICES DESIGN 7

IS:10101 NATIONAL RULES FOR ELECTRICAL INSTALLATIONS..... 8

LV POWER – WIRING SYSTEMS & INSTALLATION PRACTICES10

LV POWER - SWITCHGEAR11

LIGHTING AND EMERGENCY LIGHTING SYSTEM DESIGN12

FIRE ALARM SYSTEM DESIGN.....13

DATA CENTRES – INTRODUCTION TO M&E SERVICES14

MV POWER DISTRIBUTION DESIGN15

CRITICAL POWER INSTALLATIONS - GENERATORS & UPS SYSTEMS.....16

STANDBY GENERATORS18

UPS SYSTEMS.....19

INTRODUCTION

Trainer Profile:

I am a Chartered Engineer with over 44 years' experience in all aspects of mechanical and electrical building services including; design, installation, commissioning and maintenance. After completing an electrical apprenticeship in 1982 I went on to study electrical engineering in DIT. I worked in M&E consultancy at senior engineer / director level for almost 30 years.

In 1999 I started my own M&E consultancy, Dervan Engineering Consultants (DEC), which merged with Cundall (Consulting Engineers) in 2016. DEC / Cundall provided M&E consultancy and project management services to a diverse range of clients in both the public and private sectors.



I retired from mainstream consultancy in 2019 and set up Best Training which provides specialist CPD services to the M&E Sector. I currently represent Engineers Ireland on a voluntary basis on the NSAI's TC2 Committee for the National Rules for Electrical Installations. I am also Chair of Engineers Ireland Electrical Division (2022-2023)

I am a member of various professional bodies and committees including:

- Registered with the Engineering Council as a Chartered Engineer (C Eng.)
- Member of Engineers Ireland (MIIE)
- Fellow of the Chartered Institution of Building Services Engineers (FCIBSE),
- Member of the Institution of Engineering and Technology (MIET)
- Vice Chairperson of NSAI TC2 "Wiring Rules" Committee
- Chairperson of the Electrical Division of Engineers Ireland (2022-23)

I have published a number of guidebooks in relation to the Wiring Rules in Ireland including:

- The Wiring Rules in Ireland – An Illustrated Guide to I.S. 10101
- RECI On-site Guide to I.S. 10101

The Importance of CPD

CPD, or continuing professional development, is supplementary training and upskilling that engineer and other professionals must undertake to keep up to date with changing trends in their profession. It is essential to enhance their knowledge and bridge skills gaps.

The benefits of CPD training include greater effectiveness in the workplace and an increased level of interest in one's profession.

CPD can take the form of coaching, mentoring etc. However with an ever increasing need to close the skills gap, many companies nowadays outsource this very important function to specialist companies like Best Training who can devote the time and expertise required.

A minimum level of CPD training in the order of 40 hours per year is mandatory with most professional engineering bodies such as Engineers Ireland, CIBSE and the IET. Most employers see the rewards of CPD training and strongly encourage their staff to attend seminars, webinars and specialist CPD courses etc. to enhance their knowledge in the workplace.

GENERAL INFORMATION ON CPD COURSES

CPD Courses on Offer

The following is a list of CPD Course which Best Training provide:

- Fundamentals of M&E Consultancy
- Fundamentals of Electrical Services Design
- LV Power – Wiring Systems & Installation Practices
- LV Power - Switchgear
- Lighting and Emergency Lighting System Design
- Fire Alarm System Design
- Data Centres – Introduction to M&E Services
- MV Power Distribution Design
- Critical Power Installations - Generators & UPS Systems
- Standby Generator Systems
- UPS Systems
- New Wiring Rules (IS 10101) - Understanding the New Wiring Rules
- New Wiring Rules (IS 10101) - Chapter 7 Explored

Best Training and Engineers Ireland - Options

I can deliver the CPD courses both directly or through Engineers Ireland. The direct CPD training route is aimed at large organizations with specific training needs. Information regarding my availability for this option is provided below.

For the Engineers Ireland route there are two options available.

- You can book individually or as a small group as part of an open on-line classroom
- For larger groups you may book a dedicated in-company training session

For either of these Engineers Ireland options you should contact: cpdtraining@engineersireland.ie

Bespoke CPD Course

I can also provide bespoke CPD training courses based on the content of the existing suite of courses listed above.

Course Format

The following outlines the general format of the CPD Courses

- The courses are delivered on line using PowerPoint.
- Each course is broken into numerous sections with Q&A at the end of each
- Assessment is not included but can be provided on request
- The duration is 8 hours inclusive of lunch and morning and afternoon coffee breaks.
- Courses normally start at 9am and finish at 5pm, covering approximately 150 slides
- A maximum of 15 candidates is recommended however larger groups can be accommodated.

Presentation Material

I do not provide copies of the presentation in electronic format for obvious reasons. I recommend that attendees purchase a copy of the hand-out in advance of the course and familiarise themselves with the course material. The presentation are not recorded

Availability

The courses are normally delivered two days a week generally Tuesday or Thursday. Training is not available in July or August.

Bookings are not secured until payment or a purchase order is received. Changes to the agreed date must be confirmed in writing. An alternative date will be offered.

Quotation

The following information must be provided to enable a formal quotation to be issued:

- Preference for face to face or on-line training
- The number of attendees,
- The delivery arrangement for the course hand-outs.
- Any additional requirements as listed above e.g. CPD certs, MCQ assessment etc.

List of attendees

In advance of on-line training sessions a list of attendees will be required in the following format. The meeting invite and login details will be sent to the attendees directly.

First Name	Last Name	Company	Job Title	email
<i>John</i>	<i>Smith</i>	<i>Acme Engineering</i>	<i>Junior Electrical Engineer</i>	<i>J.smith25@XXX.com</i>

FUNDAMENTALS OF M&E CONSULTANCY

Course Ref: FME

Overview

The course covers the fundamentals of M&E Consultancy services on a typical building services construction or refurbishment project. It gives an insight into the various project stages including preparation of conditions of engagement and fee proposals; scheme design to developed design; planning process; tender process; construction stage duties; handover etc.



The course covers the relationship between the M&E consultant and other project stakeholders including the client, consultants and contractors. It gives an insight into the principal standards and codes of practice applicable to M&E consultancy services including an overview of the Building Regulations.

Course Aim

The aim of this course is to give graduate engineers and new entrants to M&E / building services consultancy a good understanding of the role of the M&E Consultant on a typical construction project from initial client enquiry through to the final handover of the project.

Learning Objectives

At the end of the course attendees will be able to discuss the role and duties of an M&E Consultant on a typical building services project as outlined in the programme below.

Programme

- Section 1 - Fee proposals, Conditions of Engagement
- Section 2 - The Project and Design Team
- Section 3 - Project Stages
- Section 4 - Contract Types and General Terms and Conditions
- Section 5 - Types of Buildings
- Section 6 - Essential requirements for M&E Engineer
- Section 7 - Overview of Mechanical Building Services
- Section 8 - Overview of Electrical Building Services
- Section 9 - Overview of Building Information Modelling / BIM
- Section 10 - M&E Surveys and Reports
- Section 11 - Climate Action Plan and SEAI Energy Reports
- Section 12 - Renewable Energy Systems
- Section 13 - Environmental and Energy Assessment Procedures
- Section 14 - Standards applicable to M&E Services
- Section 15 - Overview of the Building Regulations

Who Should Attend

This course is aimed at graduate engineers and new entrants to mechanical and electrical (M&E) building services consultancy.

Duration

1 Day – 7 Hours

FUNDAMENTALS OF ELECTRICAL SERVICES DESIGN

Course Ref: FES

Overview

This course provides an introduction to electrical services. It deals with the hazards of electricity and the associated rules and regulations in relation to safety including a brief overview of the National Rules for Electrical Installations and the Building Regulations.



The course also provides an overview of the wide range of electrical service to be found in modern buildings such as: Power systems including MV and LV distribution, generator and UPS systems; Lighting services including interior and exterior installations; Life safety systems including fire alarm, fire suppression and emergency lighting systems; Building Management Systems (BMS), Security and Telecommunications Services.

The course can precede or follow on from Fundamentals of M&E Consultancy - Course Ref (FME)

Course Aim

The aim of this course is to give graduate electrical engineers an introduction to the fundamentals of electrical buildings services design. The intention is that graduates can attend other Best Training CPD modules to receive more intensive training in selected areas throughout their workplace training period.

Learning Objectives:

At the end of the course attendees will be aware of the hazards of electricity and the wide range of electrical service to be found in modern buildings as outlined in the programme below:

Programme

- Section 1 - Electrical Services Design - Overview
- Section 2 - Understanding the Hazards of Electricity
- Section 3 - Electrical Safety Standards – The Rules and Regs
- Section 4 - The Building Regulations - Relevance to Electrical Services Design
- Section 5 - ESB Supply Arrangements – MV, LV, 1 phase and 3 Phase
- Section 6 - Power Systems - Overview
- Section 7 - Lighting Systems - Overview
- Section 8 - Emergency Lighting Systems - Overview
- Section 9 - Fire Alarm and Fire Suppression Systems - Overview
- Section 10 - Security and BMS systems - Overview
- Section 11 - Telecommunication Services - Overview
- Section 12 - ATEX / Potentially Explosive Environments - Overview
- Section 13 - Lightning Protection Systems - Overview
- Section 14 - Renewable Energy Systems for Buildings - Overview
- Section 15 - Cables and Wiring Systems - Overview
- Section 16 - Surveys, Inspections and Reports

Who Should Attend

This course will benefit graduate electrical engineers and contractors involved in the design of electrical services. The course is also suitable for mechanical engineers, quantity surveyors and facility managers who may wish to expand their knowledge of electrical building services.

Duration:

1 day – 7 Hours

IS:10101 NATIONAL RULES FOR ELECTRICAL INSTALLATIONS

Course Ref: WR1 and WR2

Overview

The National Rules for Electrical Installations, IS: 10101 as published by the National Standards Authority of Ireland, (NSAI) apply to the design, installation and verification of electrical installations, including additions and alterations to existing installations. The following one-day courses are available;

- WR1 - Understanding the New Wiring Rules
- WR2 - New Wiring Rules – Chapter 7 Explored

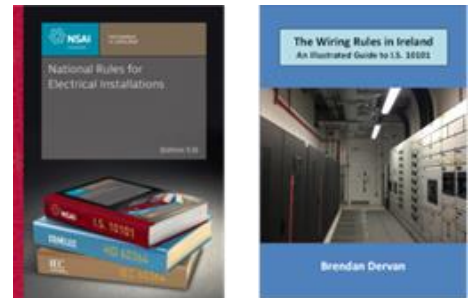

The aims and learning objectives of these two courses are given below.

Guidebook

I have published a guidebook entitled *“The Wiring Rules in Ireland – An Illustrated Guide to IS 10101”*. This is intended as a guidance document for the two one day courses WR1 and WR2. The guidebook uses simplified diagrams and tables to explain the requirements of the new standard. It is recommended that attendees purchase the guidebook in advance of doing the courses. The guidebook may be purchased on-line www.besttraining.ie or included as part of a training course,

Understanding the New Wiring Rules – 1 Day

Course - Ref WR1

Course Aim

This course is aimed at engineers and contractors involved in the design of electrical installations. Its principal aim is to give a good insight into the structure of the new 5th Edition of the National Rules for Electrical Installations – I.S. 10101. The course is presented using simplified diagrams and tables to explain the requirements of the standard with particular emphasis on Chapters 4 and 5. It also covers the main changes that have occurred since the 4th Edition.

Learning Objectives:

On completion of this course attendees will have a good understanding of the structure of the new standard, the contents of each of the seven chapters. They will have a good understanding of Chapter 4 (Protection for Safety) and Chapter 5 (Selection and Erection of Electrical Equipment). They will also have a basic understanding of Chapter 6 (Verification and Certification). However it is not intended as a hands-on training course for electricians involved in testing. Attendees will have an awareness of the twenty “Special Installations or Locations” covered in Chapter 7. However it does not go into any of these installations or locations in detail as they are covered in CPD course WR2 below.

Who Should Attend

This course will benefit electrical engineers and contractors involved in the design of electrical services for buildings.

Duration:

1 day – 7 Hours

LV POWER – WIRING SYSTEMS & INSTALLATION PRACTICES

Course Ref: LVW

Overview

This course provides an overview of the design of low voltage (LV) power distribution for buildings with particular emphasis on wiring systems and installations practices. It also covers the fundamentals of load estimation and cable sizing with some worked examples. The course can precede or follow on from “LV Power - Switchgear” (CPD Course Reference “LVS”) which focusses more on the design and selection of the LV switchgear assemblies and protective devices.



Course Aim

The aim of this course is to give electrical engineers an understanding of the principle aspects of LV power distribution design with particular emphasis on wiring systems and installations practices.

Learning Objectives:

At the end of the course attendees will have learned about the principal wiring systems and installations practices used in Ireland for LV power distribution as summarised in the programme below.

Programme

- Section 1 - ESB Supply Arrangement – 1 and 3 Phase
- Section 2 - Load Estimates - Worked Examples
- Section 3 - Typical LV Distribution Arrangements
- Section 4 - Cables and Wiring Systems
- Section 5 - Cable Management Systems
- Section 6 - Busbar Trunking Systems
- Section 7 - Sizing LV Cables - Overview of the process
- Section 8 - Wiring of Systems Specified by Others
- Section 9 - Switching & Isolation of Equipment
- Section 10 - Wiring of HVAC Services
- Section 11 - Wiring of Water Services
- Section 12 - Wiring of Catering Equipment
- Section 13 - Wiring of Miscellaneous Equipment
- Section 14 - Wiring of Fire Fighting Equipment
- Section 15 - Wiring of Transport Services
- Section 16 - Special Installations in Chapter 7 of IS10101
- Section 17 - Wiring for Medical Locations
- Section 18 - Wiring of Photovoltaic (PV) Systems
- Section 19 - Wiring of electric Vehicle (EV) Charging Systems
-

Who Should Attend

This course will benefit electrical engineers and contractors involved in the design of electrical services

Duration:

1 day – 7 Hours

LV POWER - SWITCHGEAR

Course Ref: LVS

Overview

This course provides an overview of the design of low voltage switchgear systems for buildings. The course can precede or follow on from “LV Power Wiring Systems and Installation Practices” Course Reference “LVW”



Course Aim

The aim of this course is to give electrical engineers an understanding of the principle aspects of LV distribution design with particular emphasis on design and selection of the LV switchgear assemblies and protective devices.

Learning Objectives:

At the end of the course attendees will have learned about:

- The main standards relative to LV switchgear assemblies
- How to design LV distribution boards
- How to select appropriate protective devices as listed in the programme below

Programme

- Section 1 - LV Switchgear Standards
- Section 2 - Design of LV Distribution Boards
- Section 3 - Approximate Sizing of LV MDBs
- Section 4 - Package Substations
- Section 5 - Final Distribution Boards
- Section 6 - Motor Control Centres (MCCs)
- Section 7 - Power Factor Correction Equipment
- Section 8 - Protective Devices Overview
- Section 9 - MCBs
- Section 10 - MCCBs & ACBs
- Section 11 - RCDS
- Section 12 - Fusegear
- Section 13 - Selectivity in LV Power Networks
- Section 14 - Surge Protection Devices
- Section 15 - Arc Fault Detection Devices (AFDDs)
- Section 16 - Load Transfer and key Interlocking
- Section 17 - Short Circuit Analysis
- Section 18 - Busbar Trunking Systems

Who Should Attend

This course will benefit electrical engineers and contractors involved in the design of low voltage switchgear and power distribution for buildings

Duration:

1 day – 7 Hours

LIGHTING AND EMERGENCY LIGHTING SYSTEM DESIGN

Course Ref: LEL

Overview

This course provides an overview of the design of emergency lighting systems for buildings. It follows the format of the latest Irish Standard IS 3217: 2022 on a chapter by chapter basis. This course also provides an overview of the fundamentals of design of interior lighting, exterior lighting and emergency lighting systems for buildings. It does not cover the use of lighting design software.

Course Aim

The aim of this course is to give electrical engineers an overview of the fundamentals of lighting design before going into the details of designing emergency lighting systems

Learning Objectives:

At the end of the course attendees will have learned about the fundamentals of lighting design and will have a good working knowledge of the principals of emergency lighting design to comply with IS 3217: 2022 as summarised in the programme below.

Programme

Part 1 - Fundamentals of Lighting Design

- Section 1.1 - Lighting Theory and Units
- Section 1.2 - Interior Lighting Design
- Section 1.3 - Exterior Lighting Design
- Section 1.4 - Lamps and Light Sources
- Section 1.5 - Luminaires
- Section 1.6 - Interior Lighting - Installation Practices
- Section 1.7 - Exterior Lighting - Installation Practices

Part 2 - Emergency Lighting System Design to IS 3217

- Section 2.1 - Introduction / Scope (Part 1)
- Section 2.2 - Normative references(Part 2)
- Section 2.3 - Terms and definitions (Part 3)
- Section 2.4 - Emergency lighting system types (Part 4)
- Section 2.5 - Emergency lighting design (Part 5)
- Section 2.6 - Circuits and test facilities for self-contained systems (Part 6)
- Section 2.7 - Central Power Systems (CPS) (Part 7)
- Section 2.8 – Commissioning (Part 8)
- Section 2.9 - Handover documentation and logbook (Part 9)
- Section 2.10 - Maintenance, inspections and testing (Part 10)

Who Should Attend

This course will benefit electrical engineers and contractors involved in the design of electrical building services

Duration:

1 day – 7 Hours

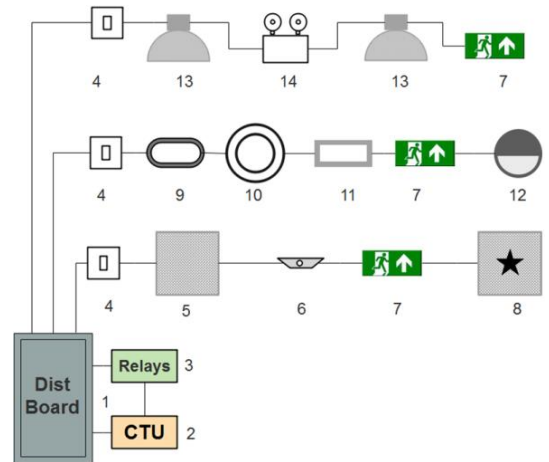

FIRE ALARM SYSTEM DESIGN

Course Ref: FAS

Overview

This course provides an overview of the design of fire detection and alarm systems for buildings. It follows the format of the latest Irish Standard IS 3218: 202X on a chapter by chapter basis.



Course Aim

The aim of this course is to give electrical engineers an overview of the fundamentals of design of fire detection and alarm systems to comply with the latest Irish Standard IS 3218: 202X. It also covers the fundamentals of fire suppression systems used in buildings.

Learning Objectives:

At the end of the course attendees will have learned about the structure of IS 3218 and fundamentals for design of fire detection and alarm systems as summarised in the programme below. They will also have gained a good understanding of the different types of fire suppression systems.

Programme

- Section 1 - Introduction to Fire Detection and Alarm Systems and IS 3218
- Section 2 - Scope, Standards and definitions - (Parts 1,2 & 3)
- Section 3 - Assessment of Needs - (Part 4)
- Section 4 - Planning and Design - (Part 5)
- Section 5 - Selection of Detectors & MCPs - (Part 5.4)
- Section 6 - Siting of Detectors & MCPs - (Part 5.5)
- Section 7 - Alarm Systems and Devices - (Part 5.6)
- Section 8 - Control and indication Equipment - (Part 5.7)
- Section 9 - Miscellaneous - (Parts 5.9 - 5.13)
- Section 10 - Installation - (Part 6)
- Section 11 - Initialization and Configuration - (Part 7)
- Section 12 - Commissioning - (Part 8.2)
- Section 13 - User Responsibilities - (Part 9)
- Section 14 - Maintenance - (Part 10)
- Section 15 - Modification of an Installed System - (Part 11)
- Section 16 - Operation of Other Fire Protection Systems - (Part 12)
- Section 17 - Applications in Special Risks - (Part 13)
- Section 18 - Hierarchical and Networked Systems - (Part 14)
- Section 19 - Fire Detection and Alarm Systems in Dwellings - (Part 15)
- Section 20 - Fire Suppression Systems Overview

Who Should Attend

This course will benefit electrical engineers and contractors involved in the design of electrical building services

Duration:

1 day – 7 Hours

DATA CENTRES – INTRODUCTION TO M&E SERVICES

Course Ref: DCI

Overview

This course provides an introduction to mechanical and Electrical (M&E) services in data centre with particular emphasis on power and cooling systems.

Course Aim

The aim of this course is to give engineers and others involved in the supply chain of data centres an introduction to the associated M&E services and in particular a good overview of the power and cooling systems.

Learning Objectives:

At the end of the course attendees will have a good understanding of the following:

- Types of Data Centres, Tier classification etc.
- Critical Systems and Redundancy
- Power systems – MV, LV, Generators and UPS
- Cooling Systems – Chilled Water, DX, Evaporative Air Cooling, Liquid / Immersion Cooling
- Building Management Systems
- Commissioning

Programme

- Section 1: Overview of DC Industry in Ireland
- Section 2: Layout of Typical Data Centres
- Section 3: Energy Usage and efficiency in DCs
- Section 4: Tiers, Resilience and Redundancy
- Section 5: Overview of Power Systems
- Section 6: MV Distribution
- Section 7: LV - Tiers I-IV - Typical Distribution
- Section 8: Standby Diesel Generators
- Section 9: UPS Systems
- Section 10: Power from UPS to Rack
- Section 11: The Basics of Cooling
- Section 12: Overview of Cooling Systems
- Section 13: DX Cooling Systems
- Section 14: Chilled Water Cooling Systems
- Section 15: Evaporative Cooling Systems
- Section 16 : Liquid & Immersion Cooling Systems
- Section 17: DC Management – BMS, DCIM
- Section 18: DC – Testing and Commissioning

Who Should Attend

This course will benefit mechanical and electrical engineers, contractors, architects, quantity surveyors and other disciplines involved in the supply chain for data centres and other mission critical projects.

Duration:

1 day – 7 Hours



MV POWER DISTRIBUTION DESIGN

Course Ref: MVD

Overview

This course provides an introduction to the design of MV distribution systems for building including the selection of the MV switchgear, transformers and cables. It does not cover design of HV systems (i.e. above 35kV) or MV systems for utility distribution, wind farms and the like.



Course Aim

The aim of this course is to give electrical engineers currently involved in LV distribution design an understanding of the principle aspects of MV distribution design for buildings

Learning Objectives:

At the end of the course attendees will have a good understanding of the following:

- The principle standards and codes of practice relating to MV distribution
- How to select the most appropriate switchgear system for a particular application
- Understand protection schemes and the function of CTs, VTs, protection relays, battery alarm tripping units and other ancillary equipment
- Understand the factors involved in selection and sizing an MV cables
- The process for testing and commissioning MV switchgear and protection systems

Programme

- 1 - The National Grid
- 2 - MV Installation Standards in Ireland
- 3 - Typical MV networks
- 4 - MV Earthing arrangements
- 5 - Connecting to the Grid at MV
- 6 - MV Switchgear Standards
- 7 - MV Circuit Breakers
- 8 - MV Instrument Transformers
- 9 - MV Protection Schemes and Relays,
- 10 - Battery alarm tripping units
- 11 - MV/LV transformers
- 12 - MV Cables - Structure
- 13 - Sizing of MV cables
- 14 - MV Testing & Safety

Who Should Attend

This course will benefit electrical engineers and contractors already involved in the design of LV power distribution systems for buildings.

Duration:

1 day – 7 Hours

CRITICAL POWER INSTALLATIONS - GENERATORS & UPS SYSTEMS

Course Ref: CPI

Overview

This course covers the design of generator and uninterruptible power supply (UPS) systems for critical power installations (CPIs) for hospitals, data centres etc. The module is a condensed version of the two separate one day courses “GEN” and “UPS” which deal with these topics in greater detail.

Please refer to programme below which also summarizes the sections of the “GEN” and “UPS” modules which are not included in this course

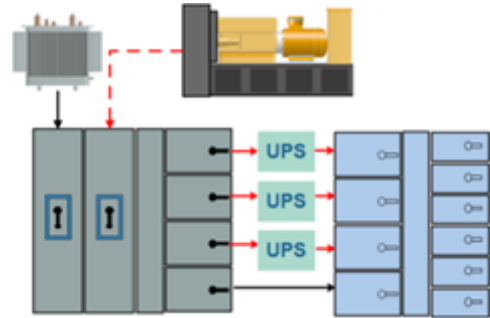

Course Aim

The aim of this course is to give electrical engineers a basic understanding of generator and UPS systems and how they are configured in LV power systems serving critical loads.

Learning Objectives:

At the end of the course attendees will have learned about the basic principles of operation of diesel powered generators and static UPS systems as used for critical power installations. They will understand the basic requirements for selecting and designing these systems and their relationship to each other.

Programme

Part 1 Critical Power Installations - Overview

- Section 1.1 Examples of Critical Power Installations
- Section 1.2 Essential versus non-essential modes
- Section 1.3 Availability time versus Autonomy
- Section 1.4 The role of the generator versus the UPS

Part 2 Standby Generators

- Section 2.1 Introduction to Gensets
- Section 2.2 Diesel Engines
- Section 2.3 Alternators
- Section 2.4 Connecting the Generator to the load
- Section 2.5 Plantrooms & Enclosures
- Section 2.6 Generator Exhaust Systems
- Section 2.7 Fuel Storage and Distribution
- Section 2.8 Generator Testing and Commissioning

The following topics from the main Generator course are not included :

- CHP Systems
- DRUPS Systems

Part 3 UPS systems

- Section 3.1 Utility Supply Disturbances
- Section 3.2 Types of UPS Systems
- Section 3.3 Efficiency in Static UPS Systems
- Section 3.4 UPS Configurations and Modes of Operation
- Section 3.5 Battery Systems
- Section 3.6 Typical UPS Specification Sheets

- Section 3.7 UPS & Generator Compatibility Issues
- Section 3.8 UPS Testing and Commissioning

The following topics from the main UPS Course are not included:

- UPS System Components
- UPS and Power Factor
- UPS Harmonic Distortion
- Rotary UPS Systems
- Static Inverter Units for Emergency Supplies

Who Should Attend

This course will benefit electrical engineers and contractors involved in the design of generator and UPS systems for critical power installations.

Duration:

1 day – 7 Hours

STANDBY GENERATORS

Course Ref: GEN

Overview

This course covers the selection and design of standby generators systems for critical power applications such as hospitals and data centres. The module is primarily focussed on diesel powered generators



Course Aim

The aim of this course is to give electrical engineers an understanding of the operation of the generator systems and how they are configured with other elements of the electrical power system to support critical loads

Learning Objectives:

At the end of the course attendees will have a deeper understanding of:

- The basic principles of operation of diesel powered generators
- The operation of the alternator, voltage and frequency control etc.
- How the generator connects to the load – load transfer and synchronizing
- Standby generators enclosures and plantrooms
- Generator Fuel Storage and Distribution System

Programme

- Section 1- Introduction to Gensets
- Section 2- Diesel Engines
- Section 3 - Alternators
- Section 4 - Connecting the Generator to the load
- Section 5 - Generators Enclosures and Plantrooms
- Section 6: Generator Exhaust Systems
- Section 7 - Fuel Storage and Distribution System:
- Section 8: Generator and UPS Compatibility
- Section 9: CHP Systems
- Section 10: DRUPS Systems
- Section 11: Generator Testing and Commissioning

Who Should Attend

This course will benefit electrical engineers and contractors involved in the supply chain of electrical services for mission critical applications such as hospitals and data centres.

Duration:

1 day – 7 Hours

UPS SYSTEMS

Course Ref: UPS

Overview

This course covers the selection and design of UPS systems for critical power applications such as hospitals and data centres. The module is primarily focussed on static systems but also provides a brief overview of rotary systems.



Course Aim

The aim of this course is to give electrical engineers an understanding of the design and operation of the UPS systems and how they are configured with other elements of the electrical power system to provide an uninterruptible supply to critical loads

Learning Objectives:

At the end of the course attendees will have a deeper understanding of:

- Fundamental principles of the operation of the UPS systems
- Modes of operation, reliability and redundancy
- Benefits of modular over block systems
- Battery Systems
- Static UPS & Generator Compatibility Issues

Programme

- Section 1: Utility Supply Disturbances
- Section 2: Types of UPS Systems
- Section 3: UPS System Components
- Section 4: Efficiency in Static UPS Systems
- Section 5: UPS Configurations and Modes of Operation
- Section 6: UPS and Power Factor
- Section 7: UPS Harmonic Distortion
- Section 8 - Battery System
- Section 9 Typical UPS Specification Sheets
- Section 10 - Rotary UPS Systems
- Section 11: Static UPS & Generator Compatibility Issues
- Section 12: UPS Testing and Commissioning

Who Should Attend

This course will benefit electrical engineers and contractors involved in the supply chain of electrical services for mission critical installations such as hospitals and data centres.

Duration:

1 day – 7 Hours